

ONEPOINTE SOLUTIONS

LABORATORY | INDUSTRIAL | COMMERCIAL



PLASTIC LAMINATE CASEWORK CATALOG

TABLE OF CONTENTS

- Welcome** 2
- Quality Policy Statement** 3
- Warranty** 4
- Casework**
 - Base Cabinets 6
 - Base Corner Cabinets 9
 - Base Waste Bin Cabinets 11
 - Sink Cabinets 13
 - Wall Cabinets 15
 - Tall Cabinets 17
 - Tall Corner Cabinets 19
- Casework Accessories**
 - Aprons & Fillers 21
 - Knee Space Panel 23
 - Concealed Hinges 24
- Countertops & Worksurfaces**
 - Laboratory Surfaces 25
 - Commercial Surfaces 26
- Finishes & Accessories**
 - Laminate Colors 27
 - Handles & Pulls 29
- Important Information**
 - Contact Us 30
 - Nationwide Service 30

WELCOME

We are honored that you are considering our plastic laminate casework for your laboratory, industrial, or commercial needs.

At OnePointe Solutions, we are continually improving the quality and versatility of our products to solve complex workspace issues. We strive to exceed each customer's expectations via our products and our outstanding customer support.

Our goal is to bring about change through better designs, higher quality components, and customer service that is second to none.

Whether your project calls for a single cabinet, a new multi-floor lab facility, or something in between we've got you covered!

We are OnePointe Solutions!



QUALITY STATEMENT

OnePointe Solutions' core business is the sale, design, layout, fabrication, and installation of custom industrial and laboratory furniture including casework, workbenches, fume hoods, and more. Our vision for growth and industry leadership is to provide aesthetically pleasing, functionally innovative, defect-free products in a timely manner.

We believe quality leadership in every functional area is necessary to remain a market leader, and as such continue to improve our Quality Management System (QMS) in line with the requirements of ISO 9001: 2015.

The OnePointe Solutions' executive team is committed to:

- Satisfying applicable requirements by ensuring that those of our customers along with any applicable statutory and regulatory requirements are determined, understood, and consistently met.
- Continuous improvement of the QMS as the governing strategic tool to capture, then communicate a shared vision to stakeholders, iterate on, and execute from with respect to achieving customer requirements and growing customer satisfaction.

The OnePointe Solutions' executive team shall:

- Maintain full accountability for the QMS.
- Consistently demonstrate quality leaderships in their respective areas of responsibility.
- Ensure the Quality Policy and respective quality objectives are established for the QMS and that they support the organizational context and strategy of the company.
- Establish quality objectives to be managed through performance data review, internal auditing, and the management review process to improve product quality, customer satisfaction and profitability.
- Utilize a process approach incorporating SIPOC and risk/opportunity based assessment.
Communicate and develop a shared understanding across the company as to the importance of quality management and QMS conformance.
- Ensure resources and personnel are available to execute to the intent and effectiveness of the QMS including providing time, training, and understanding of the strategy behind the QMS.
- Employ Kaizen as a tool for continuous improvement.
- Engage, direct, and support all personnel in their contribution towards the effective of the QMS and quality objectives.
- Partner with the supply chain on critical components to assure incorporated components meet performance and quality expectations.

This policy is communicated to all employees, organizations working in conjunction with OnePointe Solutions, and is provided to every quoted customer to share top management's vision and commitment to managing quality and continuous improvement in the design, manufacture and installation of beautiful industrial lab environments built to last.

Aaron Boto, CEO, OnePointe Solutions

WARRANTY

WHAT IS COVERED

OnePointe Solutions LLC (“OnePointe”) warrants the products sold are free of defects in materials or workmanship to the Purchaser under normal use and service for the warranty periods specified with the exceptions stated below.

WHO IS COVERED

This limited warranty only applies to an original Purchaser located in the United States, Canada, or Mexico.

HOW LONG COVERAGE LASTS

Coverage duration is dependent on the item(s) purchased, please reference the table below for details. Due to the custom nature of OnePointe’s products, there may be multiple items purchased, with different warranty durations. All warranties start from the date of shipment and run concurrently.

Item	Duration	Item	Duration
Countertops		Workbench Accessories	
Epoxy Resin*	1 Year	Lighting*	1 Year
Phenolic Resin*	1 Year**	Power Distribution*	1 Year
Laminate	1 Year	Foot Options*	1 Year
Maple Block*	1 Year	Shelving	5 Years
Stainless Steel	1 Year	Hydraulic Lifts*	1 Year
High Density Polyethelene (HDPE)*	1 Year	Uprights	Lifetime
Workbench Frames		Suspended Cabinets	
Fully Welded	Lifetime	Integrated Technology*	1 Year
Bolt Together	5 Years	Electrostatic Discharge (ESD) Devices*	1 Year
Casework / Fume Hoods		Other Furnishings	
Metal	5 Years	Chairs*	15 Years
Metal w/ Wood Fascia	1 Year	Service Fixtures*	1 Year
Fume Hoods*	1 Year	Lab Flooring*	5 Years
Blowers*	1 Year	Flammable / Chemical Safety Storage Cabinets*	1 Year
*Item is supplied by a third party; specific warranty will be assigned to the fullest extent allowed. **10 Year Delamination Warranty			

WHAT IS NOT COVERED

Defects resulting from normal wear and tear, color/grain variations, changes in surface finishes due to exposure to light, faulty installation, operation, disassembly, or remodeling, or from misuse, misapplication, neglect, abuse, accident, alteration, or the lack of proper maintenance, storage, cleaning, and care are not covered by OnePointe’s limited warranty. Products that are exposed to extreme environmental conditions or that have been subject to improper storage are not covered by OnePointe’s limited warranty. OnePointe does not provide warranty on components manufactured by others – only the original manufacturer’s warranty applies.

WARRANTY

WHAT ONEPOINTE SOLUTIONS WILL DO

OnePointe, as its sole obligation, will repair or replace (at its option) any product, part, or component covered by this warranty which fails to perform to the product's specifications. If OnePointe acknowledges that any such defects found within the warranty period are the result of faulty material or workmanship, OnePointe will repair or replace the product, part, or component with a comparable product, part, or component at its own expense. OnePointe may elect to provide on-site repair of defective product and in these cases, Buyer agrees to allow OnePointe factory technicians or authorized representative reasonable and timely access to jobsite during normal business hours. Repairs or replacement of product under warranty does not extend the original warranty period.

THERE ARE NO OTHER WARRANTIES, EXPRESSED OR IMPLIED, WHICH EXTEND BEYOND THE FACE HEREOF INCLUDING, WITHOUT LIMITATION, WARRANTIES OF MERCHANTABILITY OR FITNESS FOR A PARTICULAR USE.

The liability and remedy set forth above, in the event of a breach by OnePointe of its warranties set forth above or any of the covenants or agreements relating to the sale of the products to the Purchaser, shall be the sole and exclusive remedy to the Purchaser. In no event shall OnePointe's liability exceed the amount paid, excluding installation, by the Purchaser to OnePointe or any of its dealers or agents for the products to which the breach applies.

In no event shall OnePointe be liable to the Purchaser for any consequential or indirect damages including, but not limited to, loss of income, revenue, or profits in the event of a breach of any of the warranties or other covenants made by OnePointe with respect to the sale of OnePointe products to the Purchaser. The foregoing may not be modified except by a written amendment signed by OnePointe. The Purchaser, by accepting delivery of any product manufactured by OnePointe, hereby accepts the foregoing, and expressly waives any other remedy and damages, direct, indirect, and consequential.

HOW TO GET SERVICE

Contact OnePointe Solutions for any warranty questions or claims by phone **512.652.6292**, or email **warranty@onepointesolutions.com**. No product or parts thereof shall be returned to OnePointe or any of its dealers or agents without OnePointe's prior written consent. Product returned to OnePointe shall be shipped at buyers cost and risk of loss. Replacement product shall be returned at OnePointe's cost and risk of loss.

HOW STATE LAW APPLIES

This warranty gives you specific legal rights, and you may also have other rights which vary from state to state.



BASE CABINETS

Plastic laminate base cabinets set the stage of any room. Whether it's a conference room, breakroom, classroom or laboratory, our plastic laminate base cabinets add a different touch that you can't get anywhere else.

Our laminate cabinets are designed and manufactured from our wide selection of durable and high pressured laminate sheets to give you full design control of your cabinets. Each cabinet comes with soft-close hinges, drawer slides, and are available in a variety of heights, widths, and depths to choose from to create the ideal cabinet for you.

Built to be long-lasting and SEFA, AWI and FSC certified, our plastic laminate cabinets are unique to you and your space.

Features

- Made with High Pressure Laminate
- 3" Depth & 4" Height Toe Kick (Finished/Unfinished)
- Sturdy Back Panel
- Soft-Closing Doors and Drawers
- 1x Adjustable Shelf
- Heavy- Duty Construction
- Fully Assembled

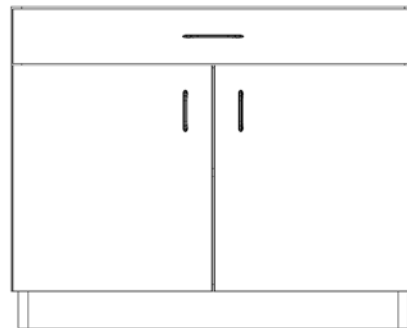

Understanding The Configuration Number

Using the model below, you will be able to better specify a cabinet configuration for your project.

PL - **BASE** - **HHWWDD** - **01L/RX**

Material Type

Cabinet Type

Cabinet Dimensions

Doors, Drawers & Locking

Drawers, Doors, Locking & Pull Details

I. Drawers

- First Number: # of Drawers (2 to 4)

II. Doors

- Second Number: # of Doors (1 to 2)
- L or R: Left or right hinged single door.
- For double doors, leave blank.

III. Locking

- X : Locking
- No for locks, leave blank.

IV. Pulls

- Plastic laminate cabinets come with wire pulls by default, unless specified.

Example: PL-BASE-291815-11L

Plastic Laminate Base Cabinet with 29" H x 18" W x 15" D, 1 Drawer, 1 Left Hinged Door, No Locking

BASE CABINET CONFIGURATIONS

HEIGHTS

SITTING

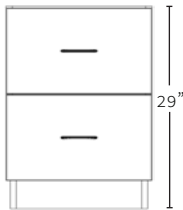

ADA

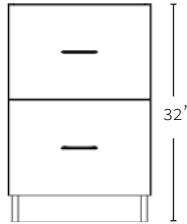

STANDARD

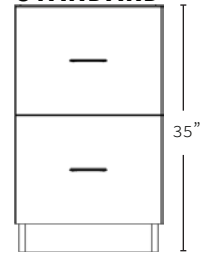

2 DRAWERS

PL-BASE-HHWDD-20X

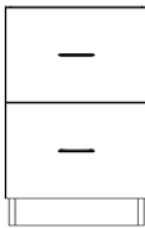

3 DRAWERS

PL-BASE-HHWDD-30X



4 DRAWERS

PL-BASE-HHWDD-40X



BASE CABINET CONFIGUARTIONS

1 DOOR

PL-BASE-HHWDD-1L/RX



(L)



(R)

BASE CABINETS WITH WIDTHS LESS THAN 24" WILL HAVE (1) DOOR.

2 DOORS

PL-BASE-HHWDD-02X

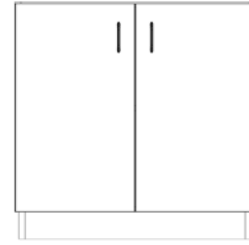

BASE CABINETS WITH WIDTHS MORE THAN 24" WILL HAVE (2) DOORS.

DUAL COMBINATIONS



PL-BASE-HHWDD-11L/RX

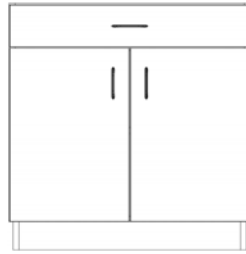

PL-BASE-HHWDD-12L/RX

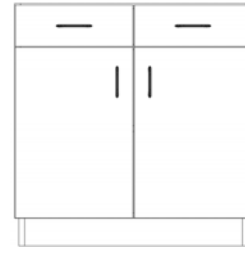

PL-BASE-HHWDD-22X

PLASTIC LAMINATE BASE CABINET CONFIGURATION OPTIONS

HEIGHTS	WIDTHS	DEPTHS	DRAWERS
29", 32", 35"	12", 15", 18", 21", 24", 30", 36", 42", 48"	12", 13", 14", 15", 16", 17", 18", 19", 20", 21", 22", 23"	0 TO 4
DOORS	HINGE DIRECTION	LOCKING	PULLS
0 TO 2	L = LEFT R = RIGHT SKIP FOR DOUBLE DOOR	X = LOCKING SKIP FOR NO LOCKS	Plastic laminate cabinets come with wire pulls by default, unless specified.

BASE CORNER CABINETS

Have a corners in your workspace? Fill them with our corner base cabinets. Just like our base cabinets, they also aid in setting the stage for your breakroom or office space. They provide easy access to materials, tools, or whatever you use in your facility that you need at your disposal.

Our laminate cabinets are designed and manufactured from our wide selection of durable and high pressured laminate sheets to give you full design control of your cabinets. Each cabinet comes with soft-close hinges, drawer slides, and are available in a variety of heights, widths, and depths to choose from to create the ideal cabinet for you.

Built to be long-lasting and SEFA, AWI and FSC certified, our plastic laminate cabinets are unique to you and your space.

Features

- Made with High Pressure Laminate
- 3" Depth & 4" Height Toe Kick (Finished/Unfinished)
- Sturdy Back Panel
- Soft-Closing Doors
- 1x Adjustable Shelf
- Heavy- Duty Construction
- Fully Assembled

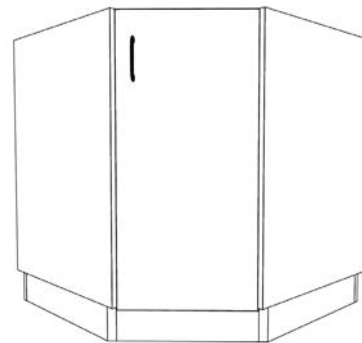

Understanding The Configuration Number

Using the model below, you will be able to better specify a cabinet configuration for your project.

PL - CBASE 40/90 - HHWWDD - L/RX

Material Type

Cabinet Type

Cabinet Angle

Cabinet Dimensions

Doors, Drawers & Locking

Doors, Locking & Pull Details

I. Doors

- L or R: Left or right hinged single door.

II. Locking

- X : Locking
- No for locks, leave blank.

III. Pulls

- Plastic laminate cabinets come with wire pulls by default, unless specified.

Example: PL-CBASE90-352415-LX

Plastic Laminate Corner Base Cabinet at 90 degree angle with 35" H x 24" W x 15" D, Left Hinged Door, Locking

BASE CORNER CABINET CONFIGURATIONS

HEIGHTS

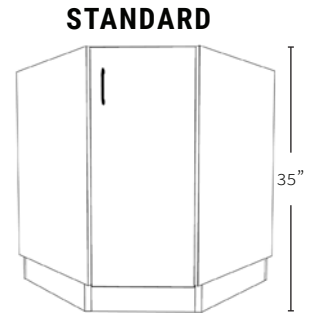
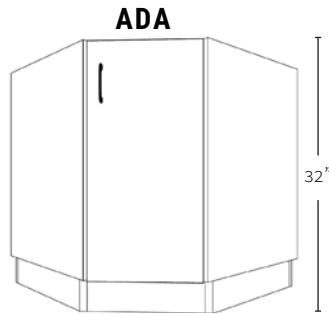
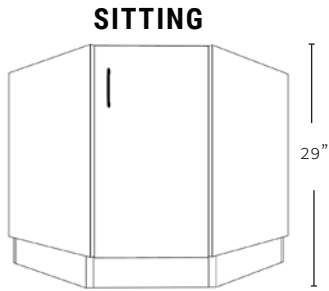

45° CORNER

PL-CBASE45-HHWDD-L/RX

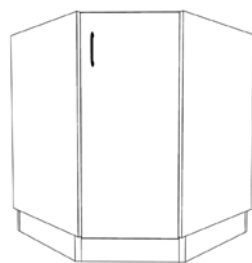
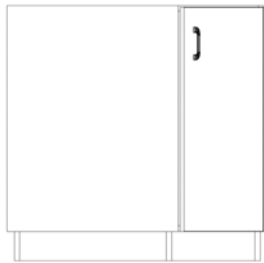

90° CORNER

PL-CBASE90-HHWDD-L/RX

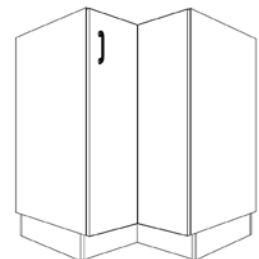
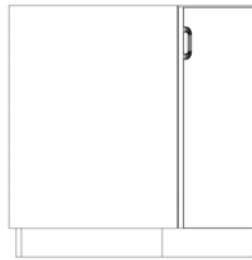

BASE CORNER CABINET CONFIGURATION OPTIONS

ANGLES	HEIGHTS	WIDTHS
45°, 90°	29", 32", 35"	40"
HINGE DIRECTION	LOCKING	PULLS
L = LEFT R = RIGHT	X = LOCKING SKIP FOR NO LOCKS	Plastic laminate cabinets come with wire pulls by default, unless specified.

BASE WASTE BIN CABINETS

Need a discreet way to throw away trash and debris? Then our waste bin cabinets are the answer. They ensure your environment is always clean and clear with waste disposal always within reach. They can easily fit into a run of cabinets, come in a range of (3) standard sizes, and can be configured to a single drawer or door style.

Available in the same high pressure laminate and soft-closing hinges as our other cabinets, our waste bin cabinets come in a variety of sizes and options so that you can choose a design that works for you. Each comes with soft-closing doors, and adjustable shelves.

Built to be long-lasting and SEFA, AWI and FSC certified, our plastic laminate cabinets are unique to you and your space.

Features

- Made with High Pressure Laminate
- Drawer & Door Options Available
- Sturdy Back Panel
- Soft-Closing Hinges
- Heavy-Duty Construction
- Fully Assembled

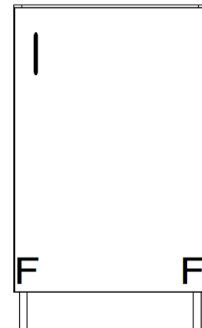

Understanding The Configuration Number

Using the model below, you will be able to better specify a cabinet configuration for your project.

PL - **WB-BASE** - **HHWWDD** - **01L/R**

Material Type Cabinet Type Cabinet Dimensions Doors, Drawers & Pulls

Drawers, Doors, & Pull Details

<p>I. Drawers</p> <ul style="list-style-type: none"> • First Number: # of Drawers (0 to 1) • For no drawers, leave blank. 	<p>II. Doors</p> <ul style="list-style-type: none"> • Second Number: # of Doors (0 to 1) • L or R: Left or right hinged single door. • For no doors, leave blank. 	<p>III. Pulls</p> <ul style="list-style-type: none"> • Plastic laminate cabinets come with wire pulls by default, unless specified.
---	--	--

Example: PL-WB-BASE-291823-10

Plastic Laminate Base Waste Bin Cabinet with 29" H x 18" W x 23" D, with 1 Drawer, No Locking

BASE WASTE BIN CABINET CONFIGURATIONS

HEIGHTS

SITTING

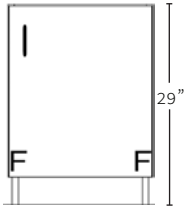

ADA

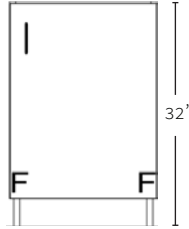

STANDARD

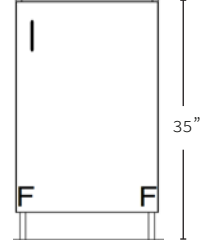

1 DOOR

PL-WB-BASE-HHWDD-01L

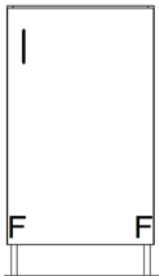

PL-WB-BASE-HHWDD-01R



1 DRAWER

PL-WB-BASE-HHWDD-10

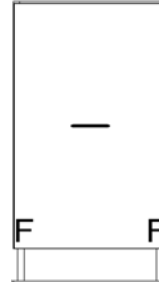

BASE WASTE BIN CABINET CONFIGURATION OPTIONS

HEIGHTS	WIDTHS	DEPTHS
29", 32", 35"	18"	23"
DRAWERS	DOORS	PULLS
0 TO 1	0 TO 1	Plastic laminate cabinets come with wire pulls by default, unless specified.

SINK CABINETS

Our sink cabinets make it easy to install sinks in a cabinet run as well as having easy access to sink usage in your workspace too. Each cabinet comes with soft-close hinges, 3" depth and 4" height toe kick, a removable false bottom for plumbing and back panel for service access.

They are available in (3) standard heights designed and manufactured from our wide selection of durable and high pressured laminate sheets to give you full design control of your cabinets. Each cabinet comes with soft-close hinges, drawer slides, and are available in a variety of heights, widths, and depths to choose from to create the ideal cabinet for you.

Built to be long-lasting and SEFA, AWI and FSC certified, our plastic laminate cabinets are unique to you and your space.

Features

- Made with High Pressure Laminate
- 3" Depth & 4" Height Toe Kick (Finished/Unfinished)
- Sturdy Back Panel
- Soft-Closing Doors
- 1x Adjustable Shelf
- Heavy- Duty Construction
- Fully Assembled

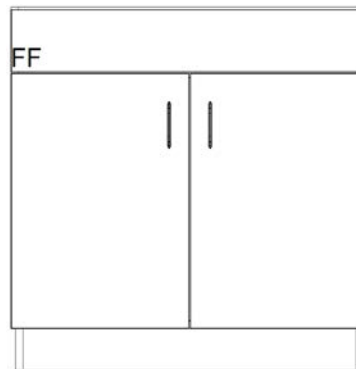

Understanding The Configuration Number

Using the model below, you will be able to better specify a cabinet configuration for your project.

PL - **SINK** - **HHWWDD** - **L/RX**

Material Type Cabinet Type Cabinet Dimensions Doors, Drawers & Locking

Doors, Locking & Pull Details

I. Doors

- L or R: Left or right hinged single door.
- For double doors, leave blank.

II. Locking

- X : Locking
- No for locks, leave blank.

III. Pulls

- A: Aluminum Pull
- W: Stainless Steel Wire Pull

Example: SINK-353622-X

Plastic Laminate Sink Cabinet with 35" H x 36" W x 22" D, Double Doors, Locking

SINK CABINET CONFIGURATIONS

HEIGHTS

SITTING

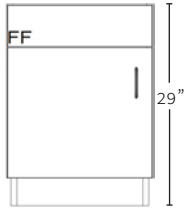

ADA

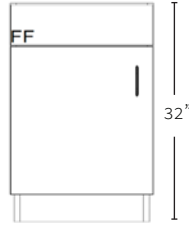

STANDARD

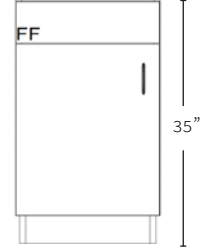

1 DOOR

PL-SINK-HHWDD-L/RX



FF = false front

SINK CABINETS WITH WIDTHS LESS THAN 30" WILL HAVE (1) DOOR.

2 DOOR

PL-SINK-HHWDD-X

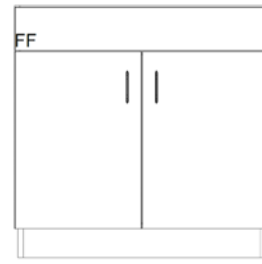

FF = false front

SINK CABINETS WITH WIDTHS OF 30" OR MORE WILL HAVE (2) DOORS.

SINK CABINET CONFIGURATION OPTIONS

HEIGHTS	WIDTHS	DEPTHS
29", 32", 35"	12" - 48" (BY 1" INCREMEMENTS)	18", 19", 20", 21", 22", 23"
HINGE DIRECTION	LOCKING	PULLS
L = LEFT, R = RIGHT WIDTHS > 24" WILL HAVE DOUBLE DOORS	X = LOCKING SKIP FOR NO LOCKS	Plastic laminate cabinets come with wire pulls by default, unless specified.

WALL CABINETS

Wall cabinets can help you create your ideal environment while providing accessible storage within arm's reach and making the most of your space as well.

Available in the same high pressure laminate as our other cabinets, our wall cabinets come in a variety of sizes and options so that you can choose a configuration that works for you. Each comes with soft-closing doors, adjustable shelves and we also provide (3) types of doors: solid, glass, or open (no door).

Built to be long-lasting and SEFA, AWI and FSC certified, our plastic laminate cabinets are unique to you and your space.

Features

- Made with High Pressure Laminate
- Door Options: Solid, Glass, Open
- Sturdy Back Panel
- Soft-Closing Doors
- 1x Adjustable Shelf
- 2x Adjustable Shelf (width > 24")
- Heavy- Duty Construction
- Fully Assembled

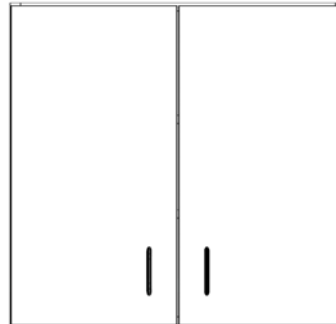

Understanding The Configuration Number

Using the model below, you will be able to better specify a cabinet configuration for your project.

PL - **WALL** - **HHWWDD** - **L/R-GX**

Material Type Cabinet Type Cabinet Dimensions Doors, Drawers & Locking

Doors, Locking & Pull Details

<p>I. Doors</p> <ul style="list-style-type: none"> • L or R: Left or right hinged single door. • For double doors, leave blank. 	<p>II. Door Type</p> <ul style="list-style-type: none"> • Solid Door: (leave blank) • G: Glass Door • O: Open Door 	<p>III. Locking</p> <ul style="list-style-type: none"> • X : Locking • No for locks, leave blank. 	<p>IV. Pulls</p> <ul style="list-style-type: none"> • Plastic laminate cabinets come with wire pulls by default, unless specified.
--	--	--	--

Example: PL-WALL-424224-GX

Plastic Laminate Wall Cabinet with 42" H x 42" W x 24" D, Double Doors with Glass, Locking

WALL CABINET CONFIGURATIONS

HEIGHTS

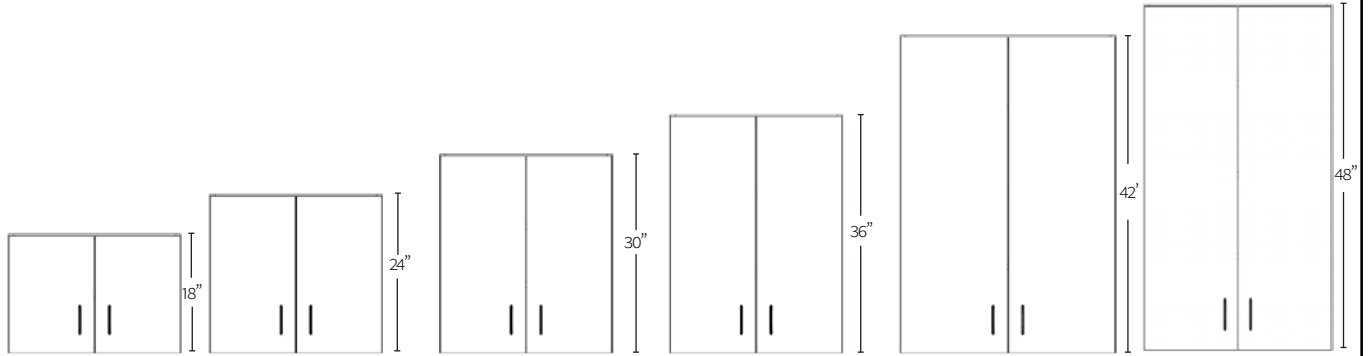

SOLID

PL-WALL-HHWDD-1L/R-X

PL-WALL-HHWDD-02-X

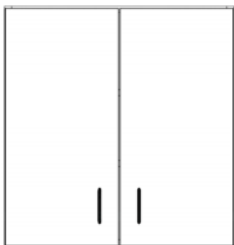

GLASS

PL-WALL-HHWDD-1L/R-GX

PL-WALL-HHWDD-02-GX

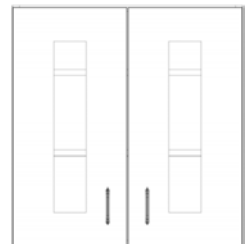
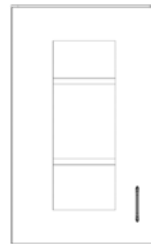

OPEN

PL-WALL-HHWDD-O

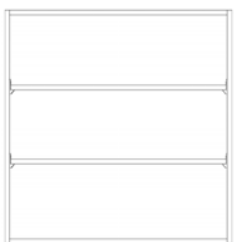

WALL CABINET CONFIGURATION OPTIONS

HEIGHTS	WIDTHS	DEPTHS
18", 24", 30", 36", 42", 48"	15", 18", 21", 24", 30", 36", 42", 48"	12", 16"

DOOR TYPE	HINGE DIRECTION	LOCKING	PULLS
SOLID = LEAVE BLANK O = OPEN G = GLASS	L = LEFT, R = RIGHT WIDTHS > 24" WILL HAVE DOUBLE DOORS	X = LOCKING SKIP FOR NO LOCKS	Plastic laminate cabinets come with wire pulls by default, unless specified.

TALL CABINETS

Plastic laminate tall cabinets are the perfect storage solution for storing more in a smaller footprint. Coming at a standard height of 84", they are built to hold more than any other cabinet.

Our tall cabinets are manufactured from our wide selection of high pressure laminate sheet colors and you can choose from multiple widths and depths to configure the right cabinet for you.

Built to be long-lasting and SEFA, AWI and FSC certified, our plastic laminate cabinets are unique to you and your space.

Features

- Made with High Pressure Laminate
- 3" Depth & 4" Height Toe Kick (Finished/Unfinished)
- 3 Door Options: Solid, Glass, Open
- Sturdy Back Panel
- Soft-Closing Doors
- 5x Shelves: (4) Adjustable (1) Fixed
- Heavy-Duty Construction
- Fully Assembled

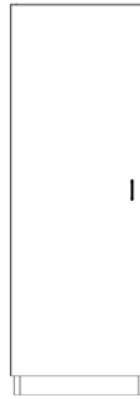

Understanding The Configuration Number

Using the model below, you will be able to better specify a cabinet configuration for your project.

PL

-

TALL

-

HHWWDD

-

L/R-GX

Material Type

Cabinet Type

Cabinet Dimensions

Doors, Drawers & Locking

Doors, Locking & Pull Details

I. Doors

- L or R: Left or right hinged single door.
- For double doors, leave blank.

II. Door Type

- Solid Door: (leave blank)
- G: Glass Door
- O: Open Door

III. Locking

- X: Locking
- No for locks, leave blank.

IV. Pulls

- Plastic laminate cabinets come with wire pulls by default, unless specified.

Example: PL-TALL-842121-R

Open Plastic Laminate Tall Cabinet with 84" H x 21" W x 21" D, 1 Door Right-Hinged, No Locking

TALL CABINET CONFIGURATIONS

HEIGHTS

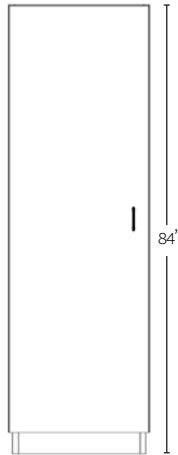

SOLID

PL-TALL-HHWDD-1L/RX



PL-TALL-HHWDD-02X



GLASS

PL-TALL-HHWDD-L/R-GX



PL-TALL-HHWDD-GX

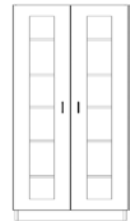

OPEN

PL-TALL-HHWDD-O



TALL CABINET CONFIGURATION OPTIONS

HEIGHTS		WIDTHS		DEPTHS	
84"		15", 18", 21", 24", 30", 36", 42", 48"		12", 13", 14", 15", 16", 17", 18" 19", 20", 21", 22", 23", 24", 25", 26", 27", 28", 29"	
DOOR TYPE	HINGE DIRECTION	LOCKING		PULLS	
SOLID = LEAVE BLANK O = OPEN G = GLASS	L = LEFT, R = RIGHT WIDTHS > 24" WILL HAVE DOUBLE DOORS	X = LOCKING SKIP FOR NO LOCKS		Plastic laminate cabinets come with wire pulls by default, unless specified.	

TALL CORNER CABINETS

Just like our tall cabinets, but made specifically for corners in a room. You can continue to supply your workspace with more storage while still only having a smallfoot.

Our tall corner cabinets come with 5 shelves: (4) removable, (1) fixed - middle shelf. They are manufactured from our wide selection of high pressure lamiante sheets and you can choose from multiple widths and depths to configure the right cabinet for you.

Built to be long-lasting and SEFA, AWI and FSC certified, our plastic laminate cabinets are unique to you and your space.

Features

- Made with High Pressure Laminate
- 3" Depth & 4" Height Toe Kick (Finished/Unfinished)
- Sturdy Back Panel
- Soft-Closing Doors
- 5x Shelves: (4) Adjusatbale (1) Fixed
- Heavy- Duty Construaction
- Fully Assembled

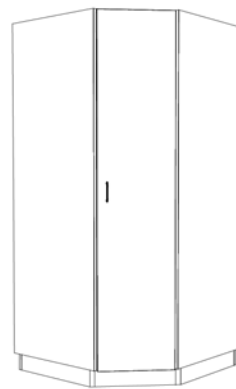

Understanding The Configuration Number

Using the model below, you will be able to better specify a cabinet configuration for your project.

PL - **CTALL** 45/90 - **HHWW** - **L/RX**

Material Type

Cabinet Type

Cabinet Angle

Cabinet Dimensions

Doors, Drawers & Locking

Drawers, Doors, Locking & Pull Details

I. Doors

- First Number: # of Doors (1 to 2)

II. Locking

- Second Number: # of Doors (0 to 2)
- L or R: Left or right hinged single door.

III. Pulls

- Plastic laminate cabinets come with wire pulls by default, unless specified.

Example: PL-CTALL45-8434-02RX

Open Plastic Laminate Tall Cabinet at 45 degree angle with 84" H x 34" W, 2 Doors, Right Hinged

TALL CORNER CABINET CONFIGURATIONS

HEIGHTS

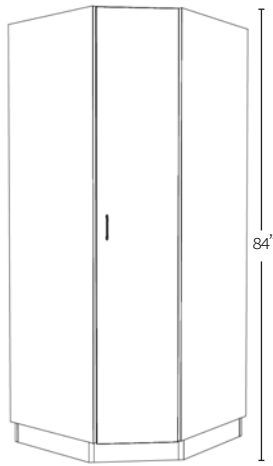

45° CORNER

PL-CTALL45-HHWDD-L/RX

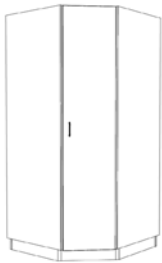

(FRONT VIEW)

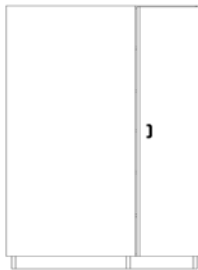

(SIDE VIEW)

90° CORNER

PL-CTALL90-HHWDD-L/RX



(FRONT VIEW)



(SIDE VIEW)

TALL CORNER CABINET CONFIGURATION OPTIONS

ANGLES	HEIGHTS	WIDTHS
45°, 90°	84"	34"
HINGE DIRECTION	LOCKING	PULLS
L = LEFT R = RIGHT	X = LOCKING SKIP FOR NO LOCKS	Plastic laminate cabinets come with wire pulls by default, unless specified.

CASEWORK ACCESSORIES - APRONS

Aprons are a great addition to your casework to create knee space for working or a storage area for

Apron Rail Only



PL-AFK-HHW

CONFIGURATION OPTIONS

HEIGHTS	29", 35"
WIDTHS	1"-12"

Apron Rail Only with False Front



PL-APRON-FF-HHWDD

CONFIGURATION OPTIONS

HEIGHTS	WIDTHS	DEPTHS
02"	24"-84"	0"

Full Depth Apron with False Front



PL-APRON-FF-HHWDD

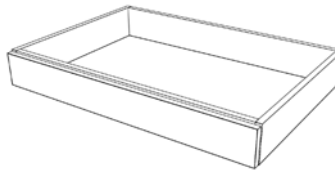

CONFIGURATION OPTIONS

HEIGHTS	WIDTHS	DEPTHS
02"	24"-84"	0"

Full Depth Apron with Drawer (1)



PL-APRON-HHWDD-10/10X

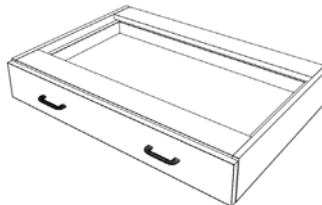

CONFIGURATION OPTIONS

HEIGHTS	WIDTHS	DEPTHS
05", 06"	12"-17"	12"-23"
DRAWERS: 1		LOCKING: X

Full Depth Apron with Drawers (2)



PL-APRON-HHWDD-20/20X



CONFIGURATION OPTIONS

HEIGHTS	WIDTHS	DEPTHS
05", 06"	12"-17"	12"-23"
DRAWERS: 2		LOCKING: X

Full Depth Apron with Drawers (3)



PL-APRON-HHWDD-30/30X

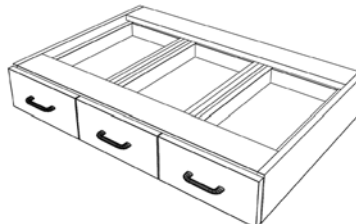

CONFIGURATION OPTIONS

HEIGHTS	WIDTHS	DEPTHS
05", 06"	12"-17"	12"-23"
DRAWERS: 3		LOCKING: X

CASEWORK ACCESSORIES - FILLERS

The walls of your environment may sometimes be off a little in terms of being vertical and straight. Fillers act as a bridge piece to align our perfectly square cabinets to an imperfect wall.

FRONT

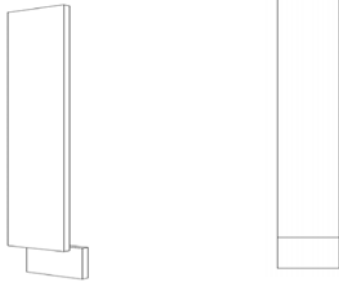

CONFIGURATION OPTIONS: PL-FFK-HHWW

HEIGHTS	WIDTHS	DEPTHS
29", 32", 35"	02" - 12"	N/A

REAR

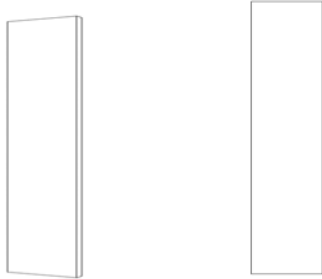

CONFIGURATION OPTIONS: PL-RFK-HHWW

HEIGHTS	WIDTHS	DEPTHS
29", 32", 35"	02" - 12"	N/A

WALL

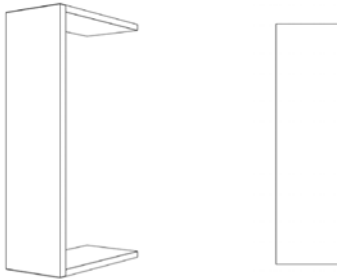

CONFIGURATION OPTIONS: PL-WFK-HHWDD

HEIGHTS	WIDTHS	DEPTHS
29", 32", 35"	03" - 12"	12", 16"

CORNER

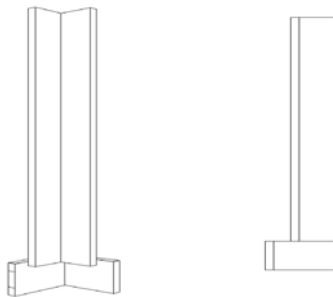

CONFIGURATION OPTIONS: PL-CFK-HHWW

HEIGHTS	WIDTHS	DEPTHS
18", 24", 30", 36", 48"	02" - 12"	N/A

WALL CORNER

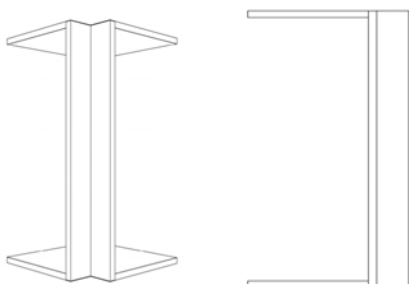

CONFIGURATION OPTIONS: PL-WCFK-HHWDD

HEIGHTS	WIDTHS	DEPTHS
24", 30", 36", 48"	02" - 12"	12", 16"

CASEWORK ACCESSORIES - KNEE & END PANELS

KNEESPACE PANEL

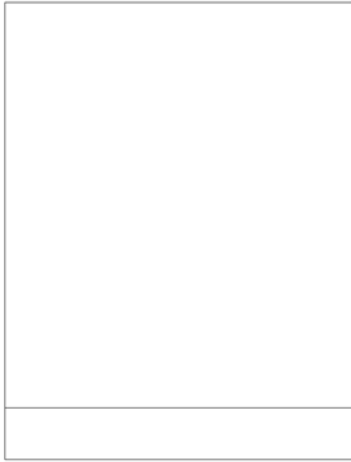

PL-KSPK-HHWW

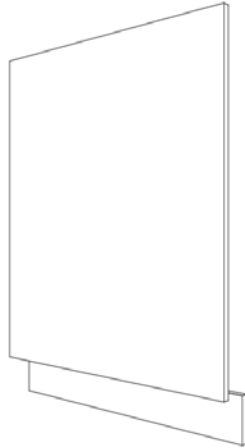

Kneespace Panel Rail Kit

PL-KSRK-WW

Our knee space panels work in either a fixed island or cabinet run. As the name entails, they can create a designated knee space where personnel can comfortably sit while they work.

CONFIGURATION OPTIONS	
HEIGHTS	29", 32", 35"
WIDTHS	24" - 45" (1 inch increments)

CONFIGURATION OPTIONS	
WIDTHS	24" - 45" (1 inch increments)

END PANELS



Notched End Panel



Regular End Panel



Our end panels are ideal for a fixed islands or a casework run as well. They can go against a set wall for better alignment of a run or help make the defined ending of an island.

CONFIGURATION OPTIONS	
HEIGHTS: 29", 32", 35", 84"	WIDTHS: 15" - 24" (1 inch increments)

CASEWORK ACCESSORIES - CONCEALED HINGES



APPEARANCE



HINGE MOTION



INNOVATIVE TECHNOLOGY

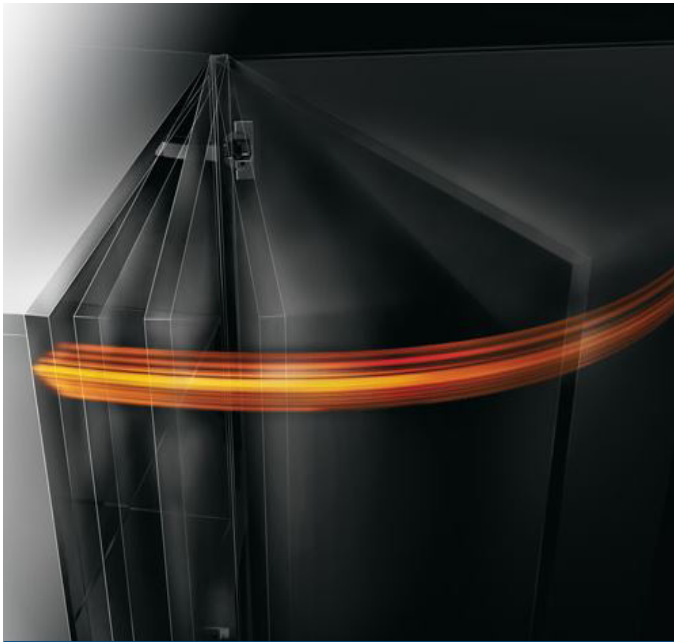

SILENT & EFFORTLESS MOTION

Features

SEFA Certified | Quieter Lab | Tested to 100,000 Cycles | Three Dimensional Adjustments | No Institutional Exposed Hinges

LABORATORY SURFACES

Epoxy Resin



Epoxy resin is a quality material that is resistant to most chemicals, moisture, impact, and heat; it's the ideal solution for environments that are very corrosive or have a high level of moisture.

Phenolic Resin



Phenolic resin countertops and tabletops meet the requirements of most laboratories while including additional benefits such as chemical, wear, and water resistance.

Stainless Steel



Stainless steel is the ultimate solution for adding resistance to your workspace. As a nonporous surface, no liquid or substance can penetrate into the material; bacteria, mold, and other common germs don't stand a chance.

ESD Laminate

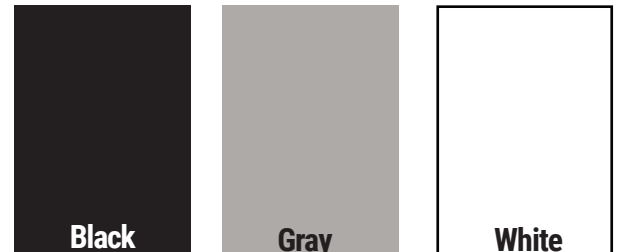

ESD Laminate or electro-static dissipative laminate is specifically designed to prevent the discharge of built-up static electricity that can damage sensitive equipment.

Solicor-CR

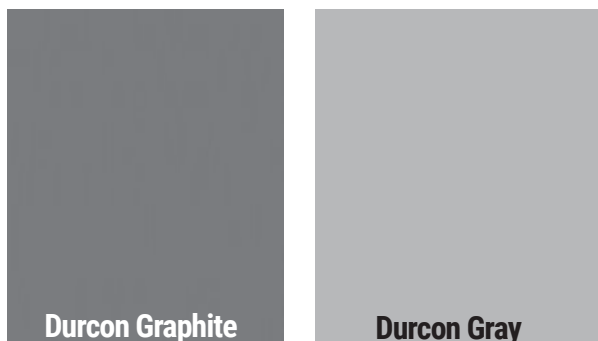

Solicor-CR is a lab-grade surface material well suited for environments, where chemical resistance, durability and aesthetics are top priorities.

HDPE

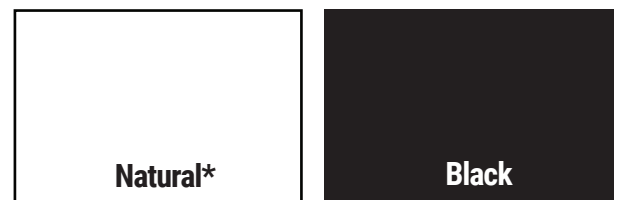

High-Density Polyethylene (HDPE) tops are lightweight and provide a non-absorbent and stain-free surface that is best used for food preparation.

*FDA approved & NSF Standard 51 certified

COMMERCIAL SURFACES

Maple Block



In the material handling business, there's no better than maple block. Maple works hard in factories in kitchens, and on shipping and receiving docks around the world.

Granite



Granite countertops are an elegant, timeless, and extremely durable surface option. They bring any commercial or industrial space to life with its many colors and smooth finish.

For our granite countertop colors, please contact us.

Quartz



Quartz countertops are favored by designers in various commercial industries since quartz can easily withstand extended use, regular cleaning, and exposure to moderate heat, moisture, and most household/commercial cleaners.

For our quartz countertop colors, please contact us.

Plastic Laminate

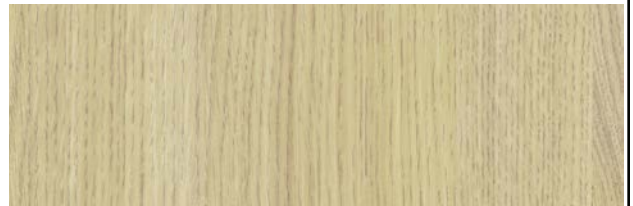

Made to align perfectly with your target aesthetic, layout, and budget. From breakrooms and reception areas to conference rooms, classrooms and even laboratories, plastic laminate countertops complement virtually any environment it is in.

For our plastic laminate countertop colors, please contact us.

Wilsonart® Solid Surface



At OnePointe Solutions, we carry a plethora of Wilsonart® Solid Surface options. Wilsonart® Solid Surface countertops are great for use in many settings: office, retail, industrial, healthcare, education and in certain laboratory settings. It is a nonporous, seamless, elegant material that can mimic the look of granite, marble, and even stone. For more solid surface options, please contact us.

LAMINATE COLOR OPTIONS

Featured below are some of our plastic laminate casework color options. To view our full color offerings, ask us for our full catalog.

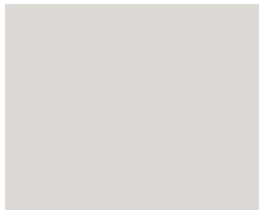

1500-60
Grey



7929-38
Huntington Maple



D315-60
Platinum



7919K-78
Amber Cherry



7971K-12
Uptown Walnut



8209K-28
Veranda Teak



1595-60
Black



7949-38
Asian Night



D96-60
Shadow

All trademarks, service marks, and trade names are proprietary to Wilsonart LLC. All rights not expressly licensed hereunder are reserved by Wilsonart LLC.



W414
Cherry Jubilee



W415
Chocolate Hazelnut



W423
Dark Zebrano



W473
Ash Marquetry



W429
Vanilla Bean Tekka



S581
Jasper



S577
Graphite

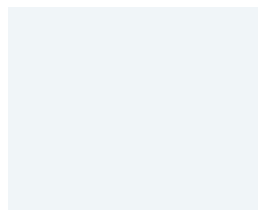

S575
Ultra White

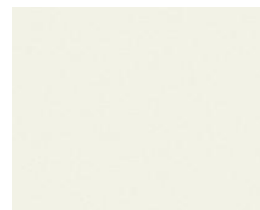

S550
Elegant White

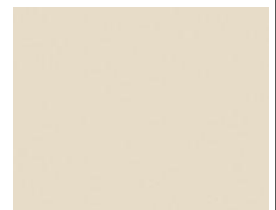

S445
Almond

Arborite Canada is a business unit of Wilsonart Engineered Surfaces. All trademarks, service marks, and trade names are proprietary to Wilsonart LLC. All rights not expressly licensed hereunder are reserved by Wilsonart LLC.

LAMINATE COLOR OPTIONS

Featured below are some of our plastic laminate casework color options. To view our full color offerings, ask us for our full catalog.



346
Natural Oak

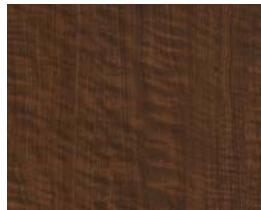

3485
Black Walnut



3485
Smokey Brown Pear



6208
Glamour Cherry



6413
Silver Riftwood



7008
Acajou Mahogany



7759
Select Cherry



8842
Weathered Ash



9236
Noble Magohany



8849
Natural Teak

Formica® is a trademark of The Diller Corporation.



WA0001 SD
Golden Anigre



WZ2001 T
Santa Rosa Plum Tree



WM8350
Carmel Sagawood



WZ017
Gallow Burl

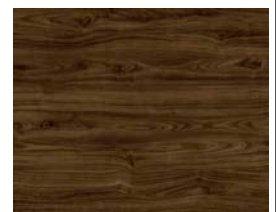

WW3100
Stout Walnut



WK023
Marocchino

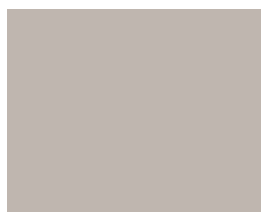

S6012
Neutral Gray



S5052
Woodvine



S3022
Deep Blue



S6053
Jett Black

Nevamar is a registered trademark of Panolan Industries.

HANDLES & PULLS

Stainless Steel Wire Pull



HÄFELE

We have partnered with Häfele America Co. to give you a multitude of handle options for your plastic laminate furniture. If it's possible, we can get you any handle you desire. Below are some options, to see a full catalog of pull and handle options, please contact us.

Häfele Handles



Item No. 155.00.980



Item No. 155.99.032



Item No. 134.03.241



Item No. 111.95.191



Item No. 155.00.040



Item No. 111.95.123



Item No. 104.74.061



Item No. 117.05.600



Item No. 111.95.184



Item No. 125.688.051



Item No. 107.18.612

Handles and pulls other than our standard stainless steel wire pull will result in longer lead times of laminate casework.

IMPORTANT INFORMATION

CONTACT US

1112 Swenson Blvd, Elgin, Texas 78621 | (866) 612-7312

www.onepointesolutions.com | info@onepointesolutions.com

NATIONWIDE SERVICE

Our team travels to you to make sure that we understand your needs, get the right measurements, and install the final product on time. Our projects can be found in: New York, Chicago, Los Angeles, San Antonio, Dallas, Houston, Atlanta, Cheyenne, Des Moines, San Diego, Washington DC, San Francisco, Nashville, Honolulu, and just about everywhere else. Want to view a reference project in your area? Just ask!

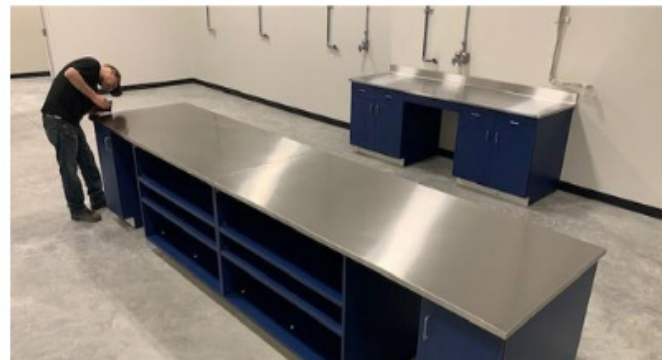



NOTES





NOTES



ONEPOINTE SOLUTIONS



(866) 612-7312

www.onepointesolutions.com